

4U SERIES

ULTRA-MINIATURE ROCKER SWITCH

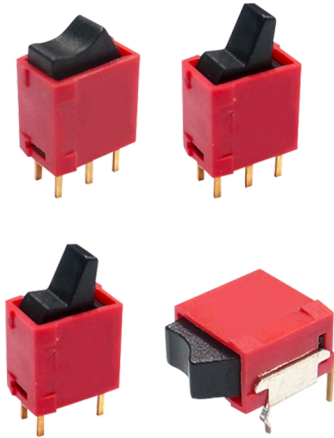

SPECIFICATIONS

CONTACT RATING: 0.4 VA max. @ 20 V AC or DC max.

MECHANICAL LIFE: 40,000 make-and-break cycles.

CONTACT RESISTANCE: 100 mΩ typ. initial @ 2-4VDC, 100mA.

INSULATION RESISTANCE: DC500V 500 MΩ.

DIELECTRIC STRENGTH: 500 Vrms min@sea level.

OPERATING TEMPERATURE: -30°C to 85°C.

MATERIALS

CASE & BUSHING : Glass filled nylon 6/6, flame retardant, heat stabilized (UL94V-0).

ACTUATOR: Nylon, black std.

SWITCH SUPPORT: Brass or steel, tin plated.

CONTACTS/TERMINALS: Gold plated copper alloy.



SWITCH FUNCTION

NO. POLES	MODEL NO.	SWITCH FUNCTION			CONNECTED TERMINALS / SCHEMATIC		
		POS.1	POS.2	POS.3	POS.1	POS.2	POS.3
SP	4US1	ON	NONE	ON	5-6 	OPEN	5-4
DP	4UD1	ON	NONE	ON	5-6, 2-3 	OPEN	5-4, 2-1

MOM=MOMENTARY

ACTUATOR OPTIONS / PANEL MOUNT

R1

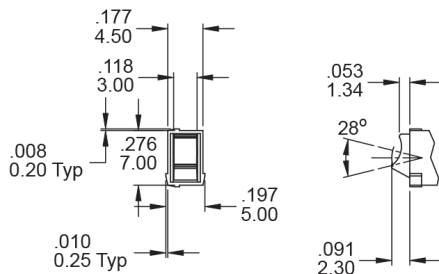

R2

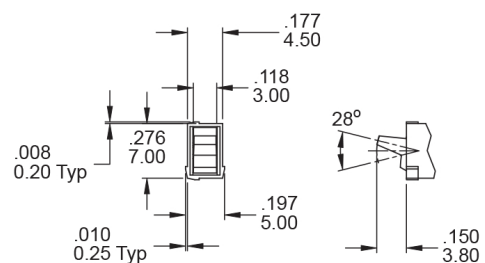

POLE OPTIONS

M2

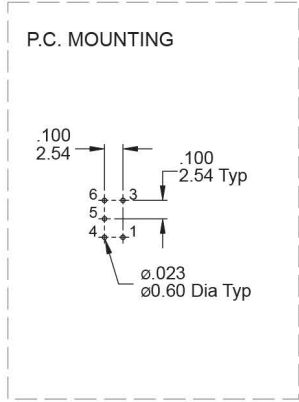
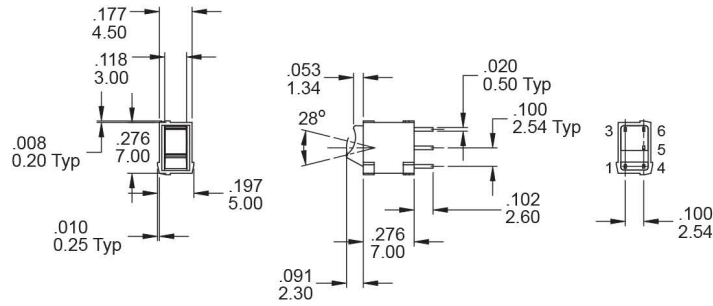

SPDT

M2

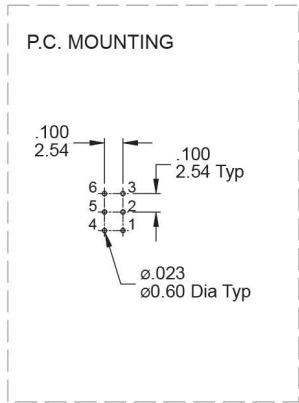
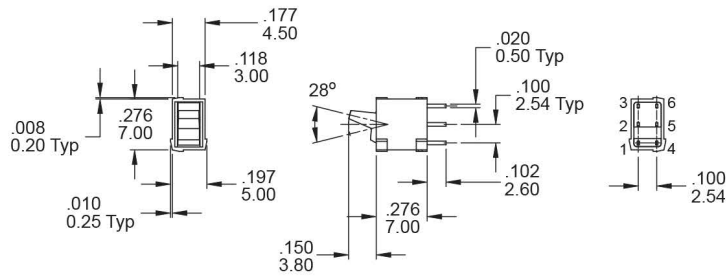

SPDT

M6

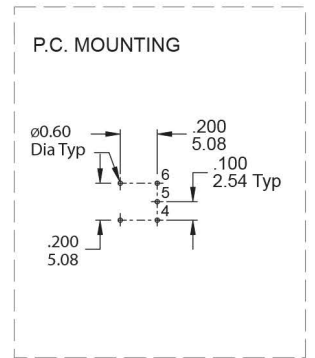
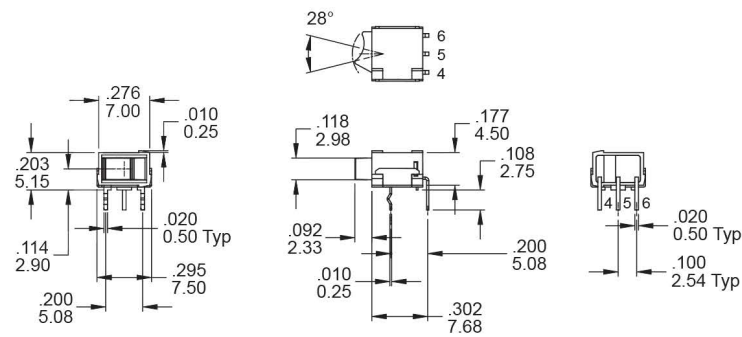

SPDT

M6

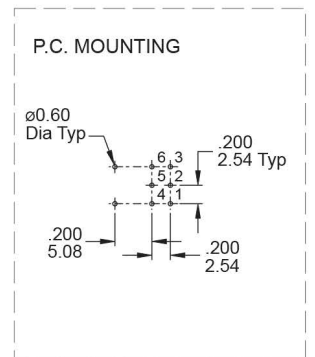
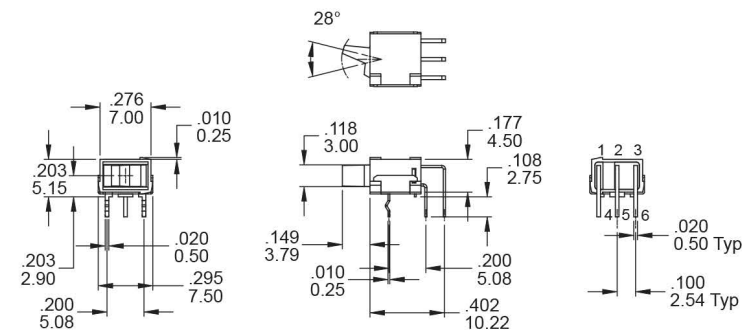

DPDT

4U SERIES

ULTRA-MINIATURE ROCKER SWITCH



M7

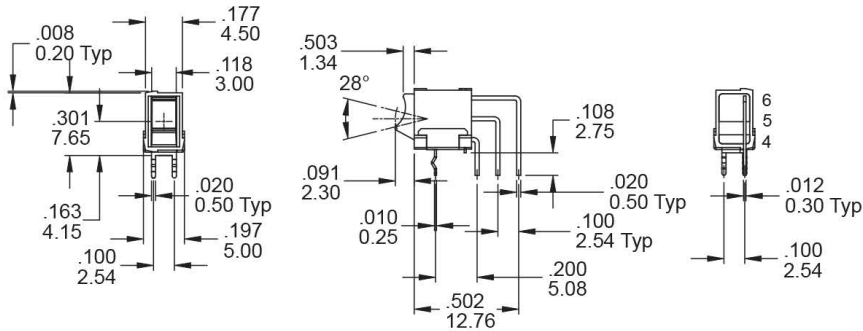

P.C. MOUNTING

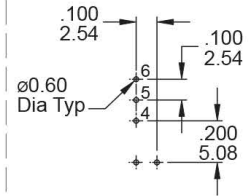

SPDT

M7

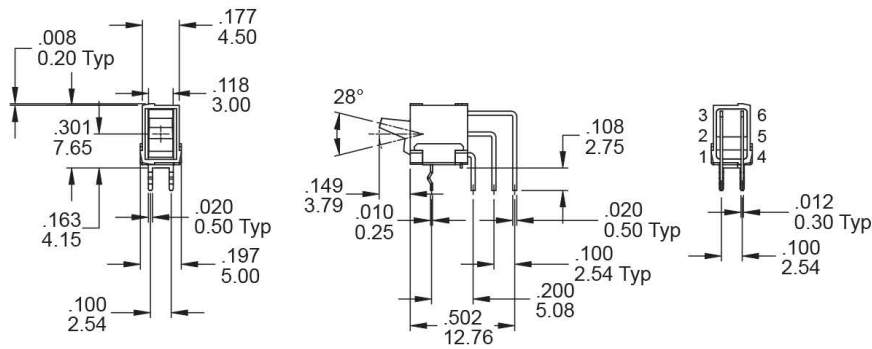

P.C. MOUNTING

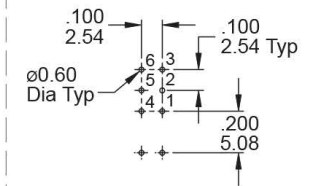

DPDT

SOLDERING PROCESSES

WAVE SOLDERING: Recommended Soldering Temperature: $260 \pm 5^\circ\text{C}$

Duration of Solder Immersion: Max 5 sec. (PCB is 1.6mm in thickness)