

# RJSMS22E SERIES

SELECTOR SWITCH



## Positions

Sort	Reset Type				Key out Position						
	Maintained	Momentary									
3Position	⊗	⊙			⊘	⊘		⊘			
Code	2	0			A	B		D			
3Position	⊕	⊖	⊖	⊖	⊘	⊘	⊘	⊘	⊖	⊖	⊖
Code	3	7	6	1	A	B	C	D	E	F	G

Selector/Key basic rotation angle 90°

## Specifications

Operating Temperature	-20~+55°C	
Operating Humidity	45~85%	
Store Temperature	-45~+80°C	
Store Humidity	95%RH	
Degree of Protection	IP65(IEC 60529) IP20(IEC 60529)	
Insulation Resistance	100MΩ	500V DC
Dielectric Strength	2,500VAC/1 2,000VAC/1	
Vibration Resistance	10~500Hz	0.35mm 50m/s <sup>2</sup>
	10~500Hz	0.35mm 50m/s <sup>2</sup>
	5~55Hz	0.5mm
Shock resistance	30Hz	1.5mm
	150 m/s <sup>2</sup>	
	1,000 m/s <sup>2</sup>	
Mechanical Life	100 m/s <sup>2</sup>	
	1,000 m/s <sup>2</sup>	
	250,000	
	5,000,000	
	1,000,000	
Electrical Life	250,000	
	100,000	
	50,000	

## Contact Ratings

	Rated insulation voltage	600V				
		Rated current				
		10A				
	Rated voltage	24V	120V	240V	380V	
AC (50/60Hz)	(AC-12)	10A	10A	6A	2A	
	(AC-15)	10A	6A	3A	1.9A	
DC	(DC-12)	8A	2.2A	1.1A	-	
	(DC-13)	4A	1.1A	0.55A	-	

## LED Ratings

Unit type	Operating Voltage	Current consumption	Color code
LSED-6②	6V AC/DC	10mA(A, R, Y) 7mA(G, PW, S)	A: Amber G: Green PW: White R: Red S: Blue Y: Yellow
LSED-1②	12V AC/DC	14mA(A, R, Y) 13mA(G, PW, S)	
LSED-2②	24V AC/DC	14mA(A, R, Y) 13mA(G, PW, S)	
LSED-H②	110V AC/DC	5mA	
LSED-M3②	230/240V AC/DC	3mA	

## How to Order

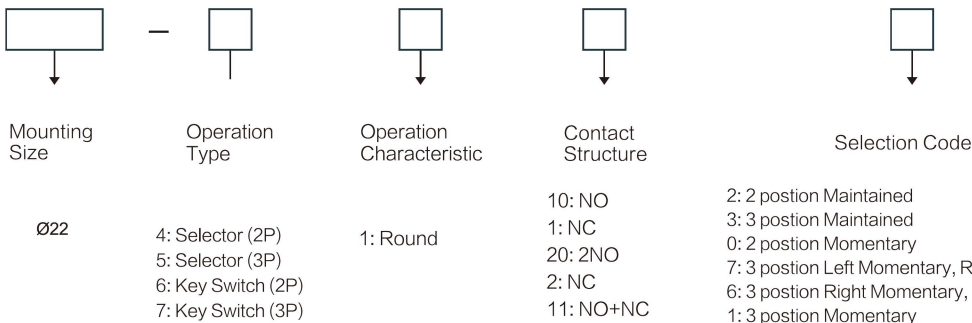



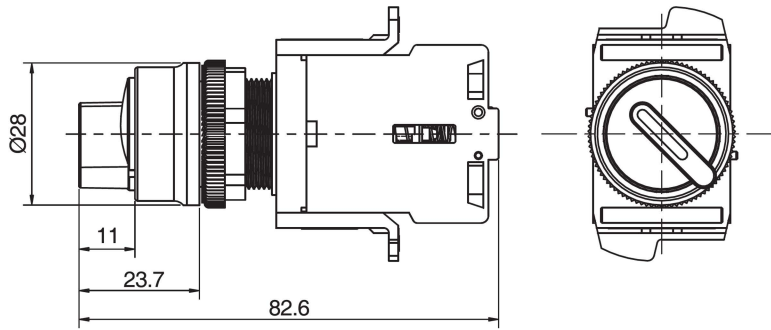

# RJSMS22E SERIES

SELECTOR SWITCH

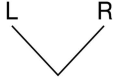
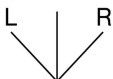

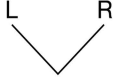
Suggested Panel Cut-out

Product appearance	Illuminated type	Positions	Operation	Contact	Model	Rated Voltage	
Selector Switches 	Without LED		Momentary	1NO	RJSMS22E--4110-0	D:24VDC E:12VDC F:6.3VDC A1:110VAC A2:220VAC	
				1NC	RJSMS22E- 4101-0		
				2NO	RJSMS22E- 4120-0		
				2NC	RJSMS22E- 4102-0		
			1NO+1NC	RJSMS22E- 4111-0			
			Maintained	1NO	RJSMS22E- 4110-2		
		1NC		RJSMS22E- 4101-2			
		2NO		RJSMS22E- 4120-2			
		2NC		RJSMS22E- 4102-2			
		1NO+1NC		RJSMS22E- 4111-2			
				Maintained	2NO		RJSMS22E- 5120-3
			2NC		RJSMS22E- 5102-3		
1NO+1NC	RJSMS22E- 5111-3						
/Selector Switches with LED 	With LED				Momentary	1NO	RJSMS22E- 4710-0
						1NC	RJSMS22E- 4701-0
						2NO	RJSMS22E- 4720-0
		2NC		RJSMS22E- 4702-0			
		1NO+1NC		RJSMS22E- 4711-0			
		Maintained		1NO	RJSMS22E- 4710-2		
			1NC	RJSMS22E- 4701-2			
			2NO	RJSMS22E- 4720-2			
			2NC	RJSMS22E- 4702-2			
			1NO+1NC	RJSMS22E- 4711-2			
				Maintained	2NO	RJSMS22E- 5720-3	
		2NC			RJSMS22E- 5702-3		
1NO+1NC	RJSMS22E- 5711-3						